

SINGER
34K1,K5,K11

Form K5868
Supersedes K1549

ILLUSTRATED
LIST OF PARTS

FOR

Class 34K Machines

(Nos. 34K1, 34K5 and 34K11)



**A Trade Mark of
THE SINGER MANUFACTURING COMPANY

From the library of: Diamond Needle Corp

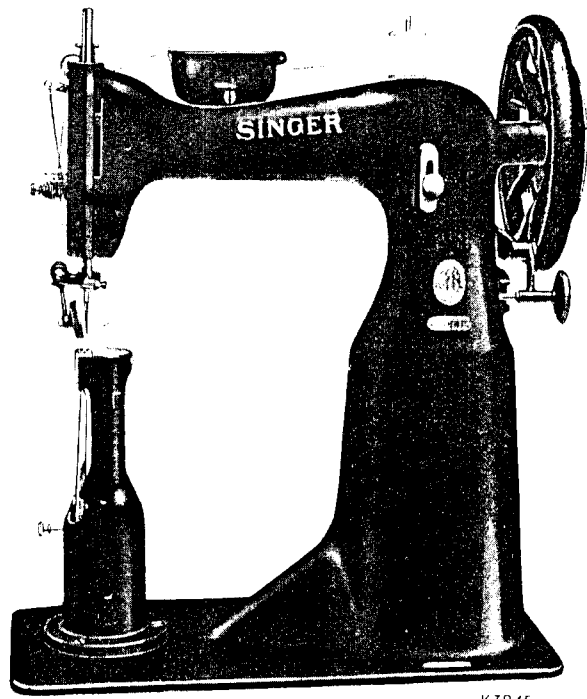

K3845

No. 34K11 Machine.

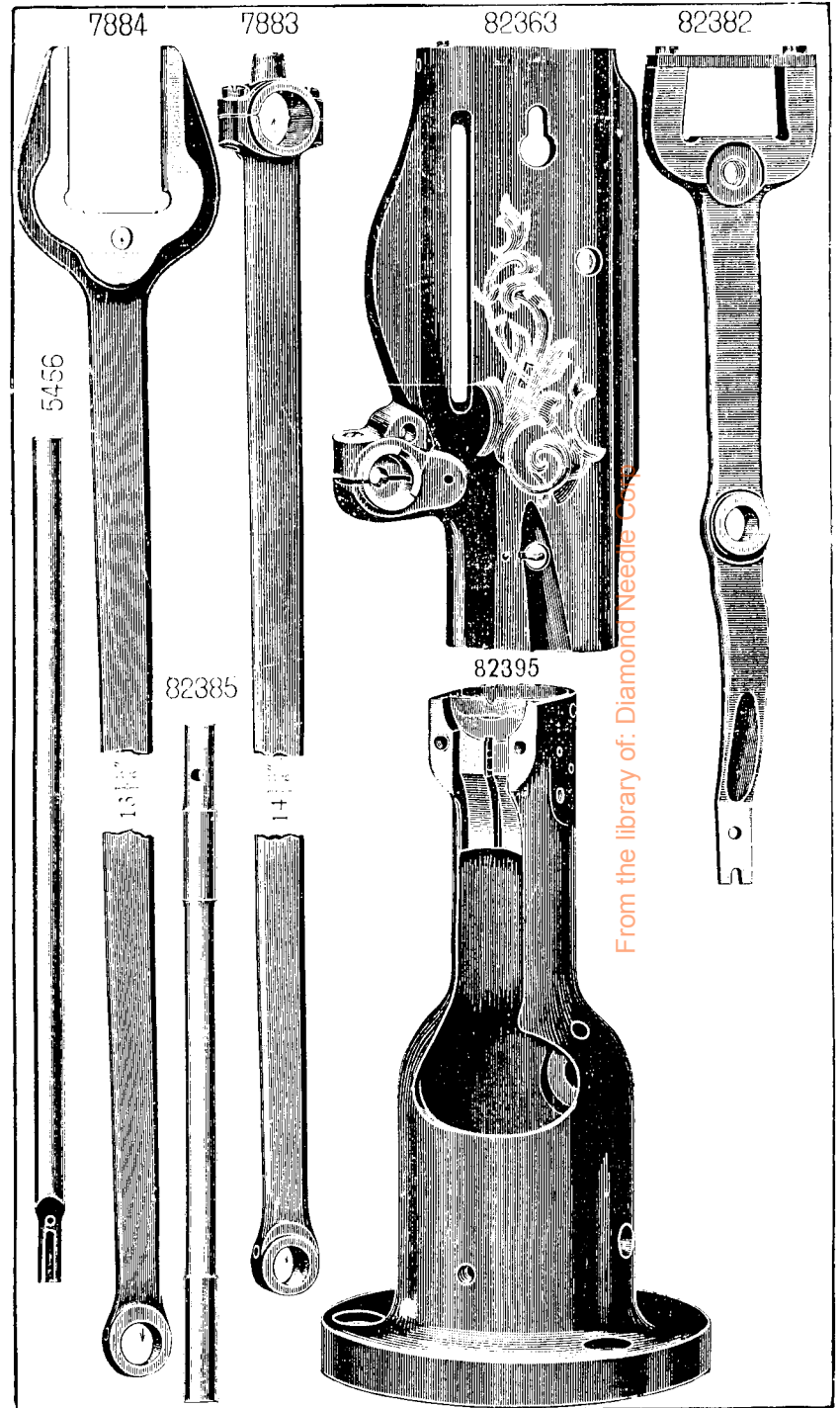

From the library of: Diamond Needle Co.

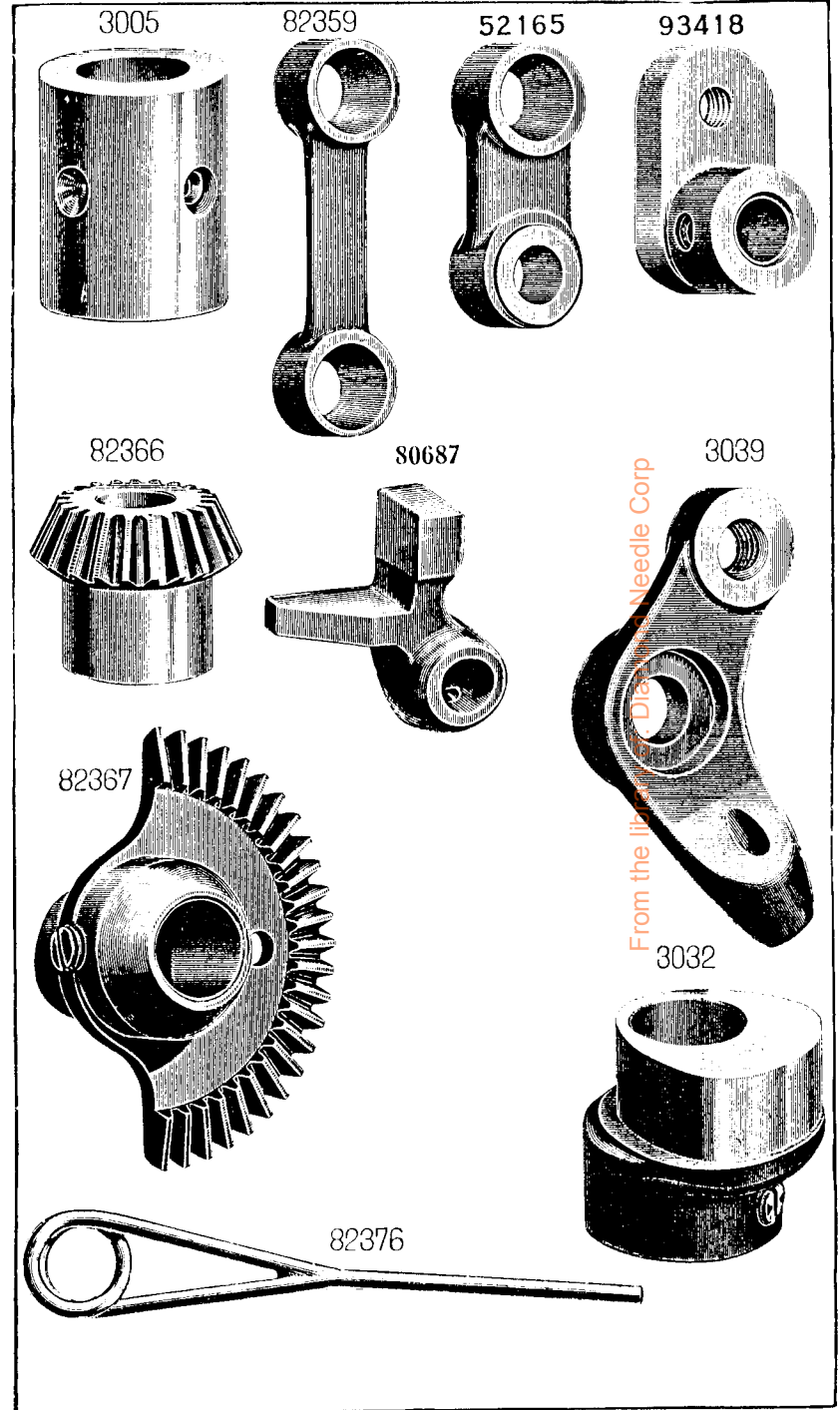
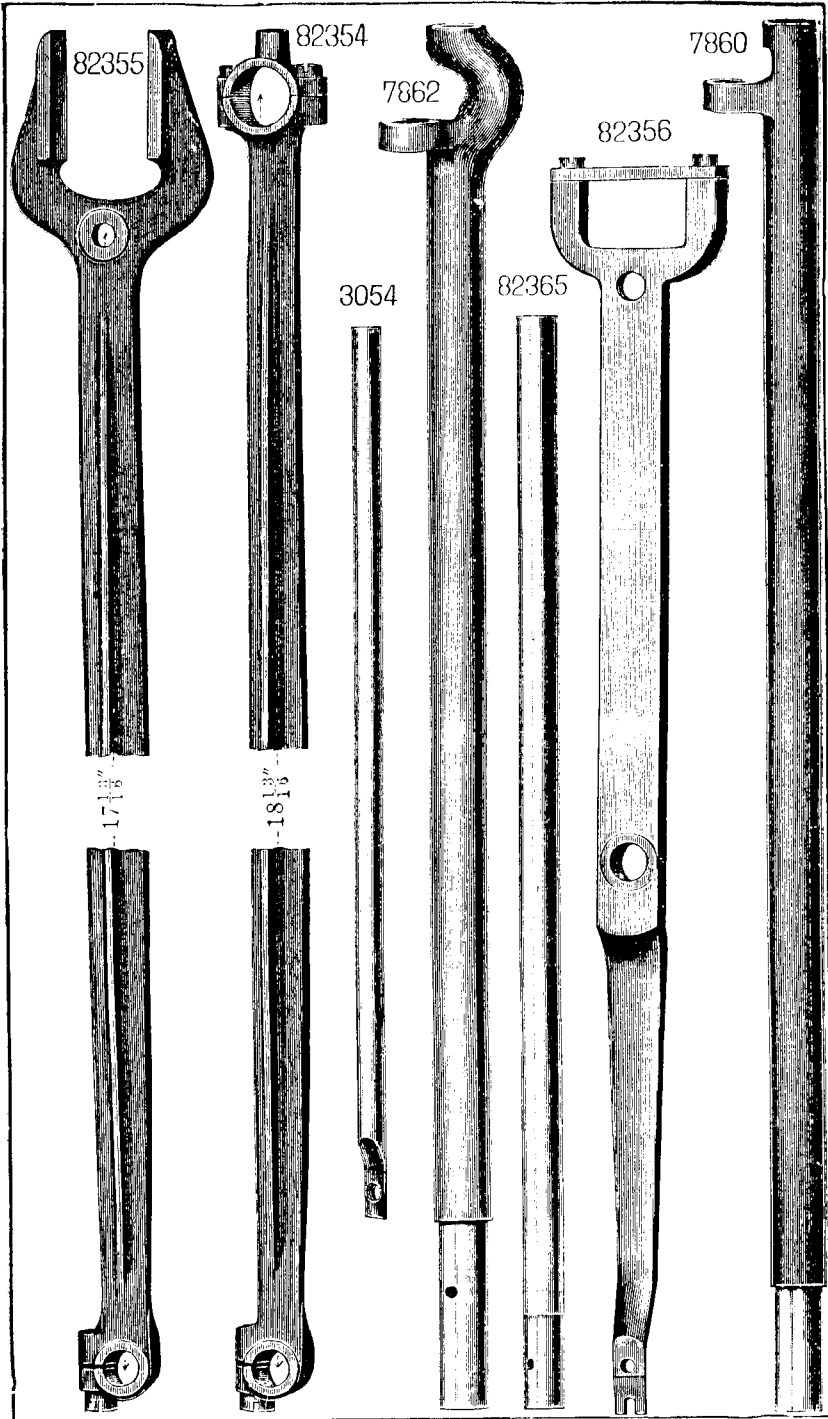

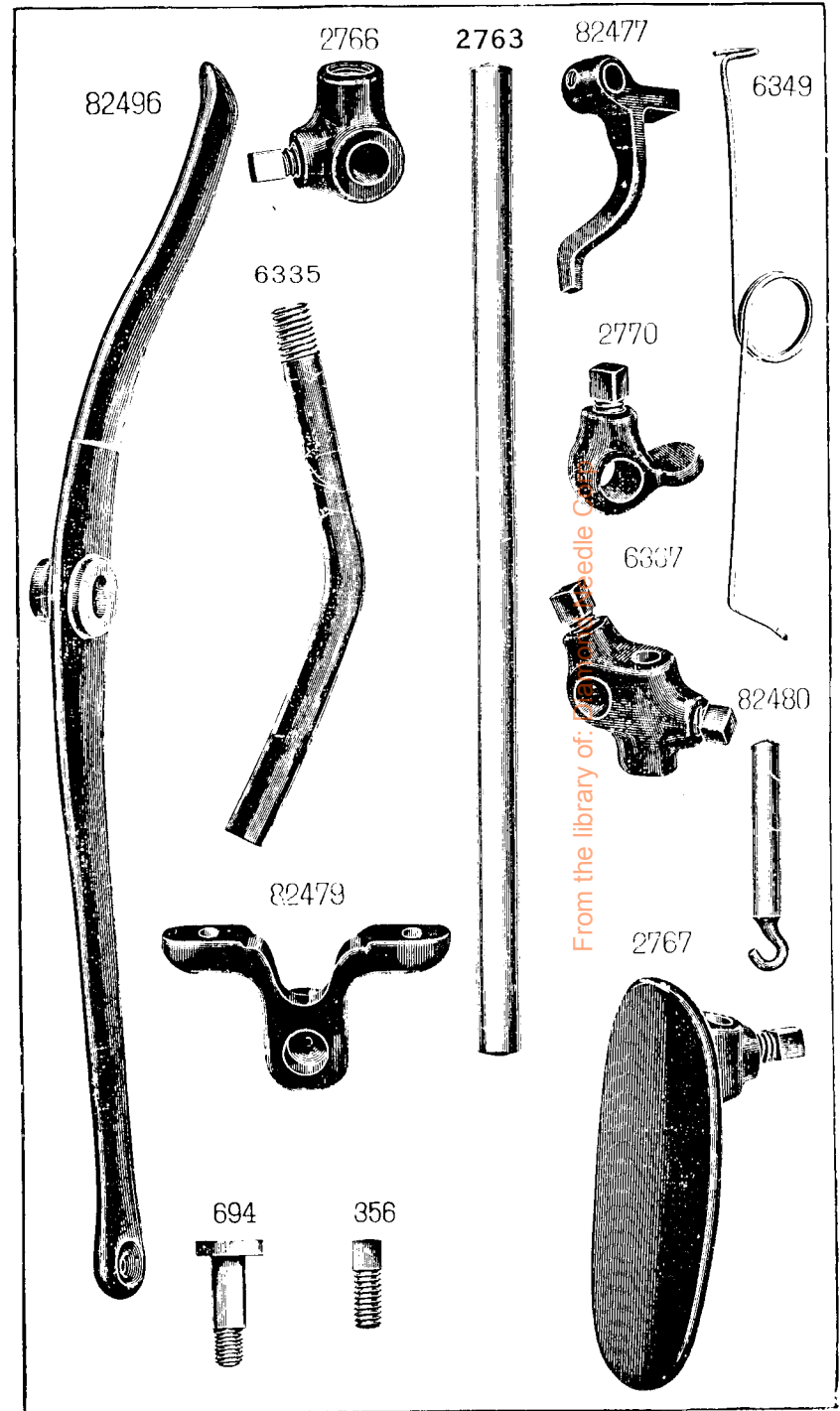
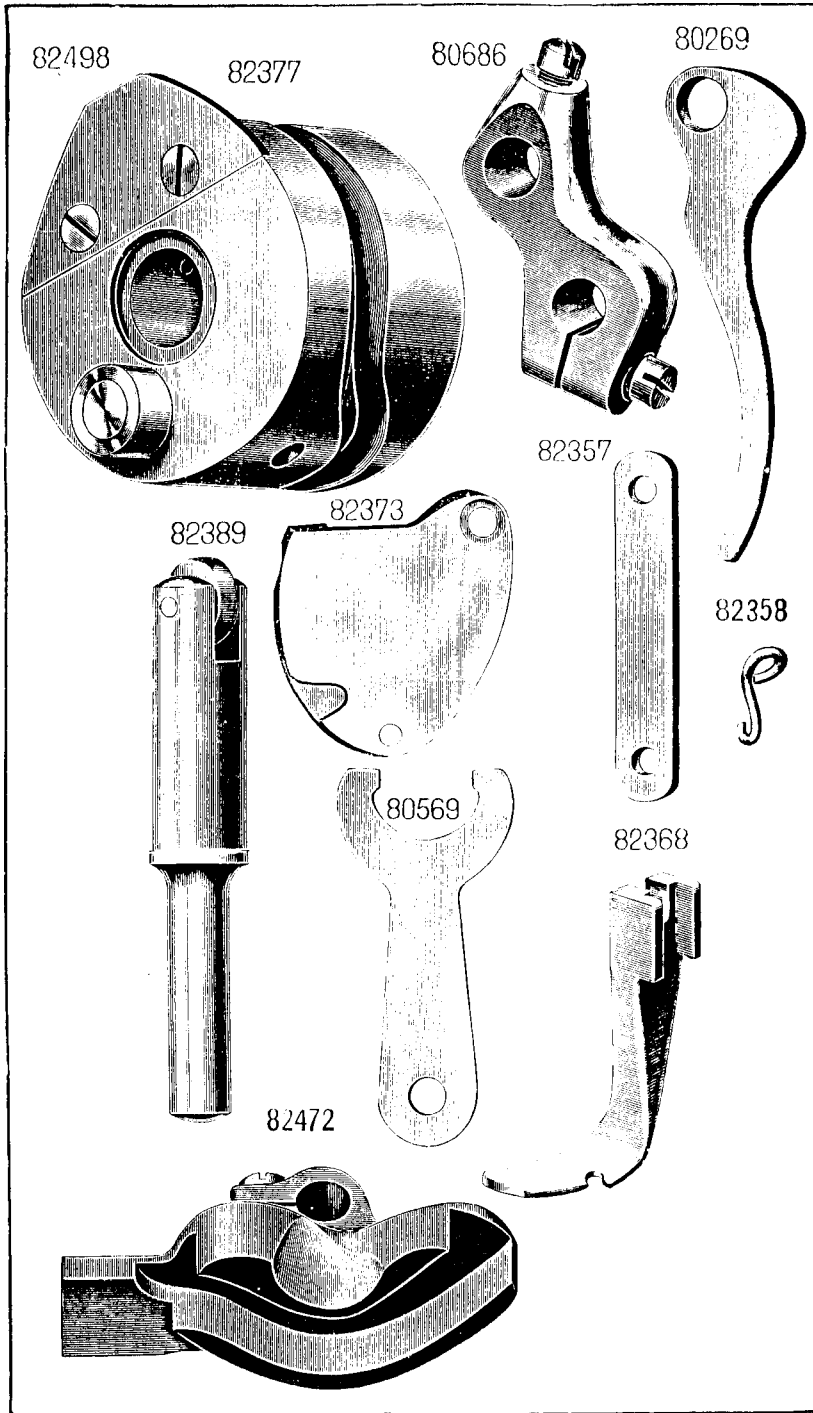

From the library of [Case Needle Co.](#)

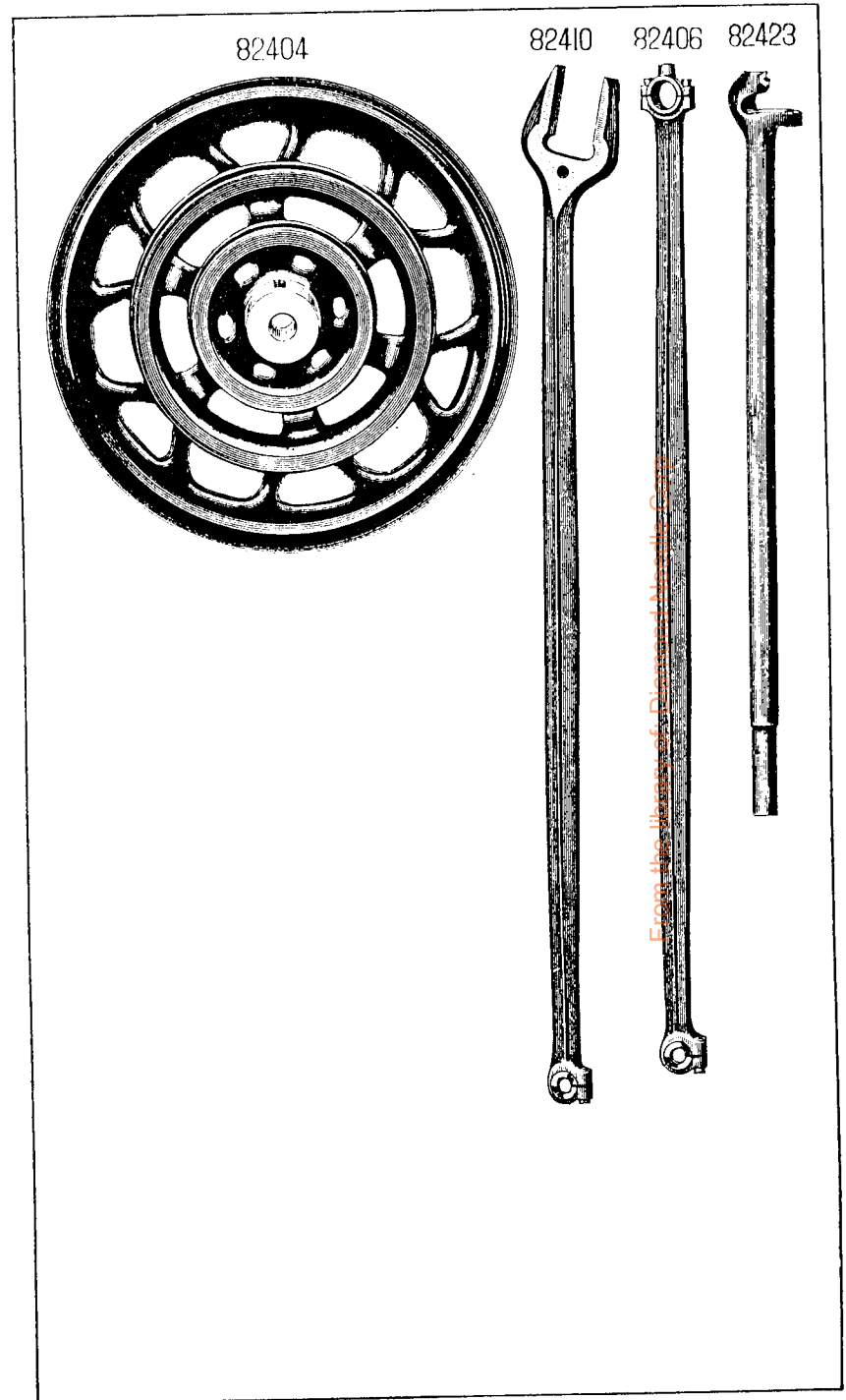
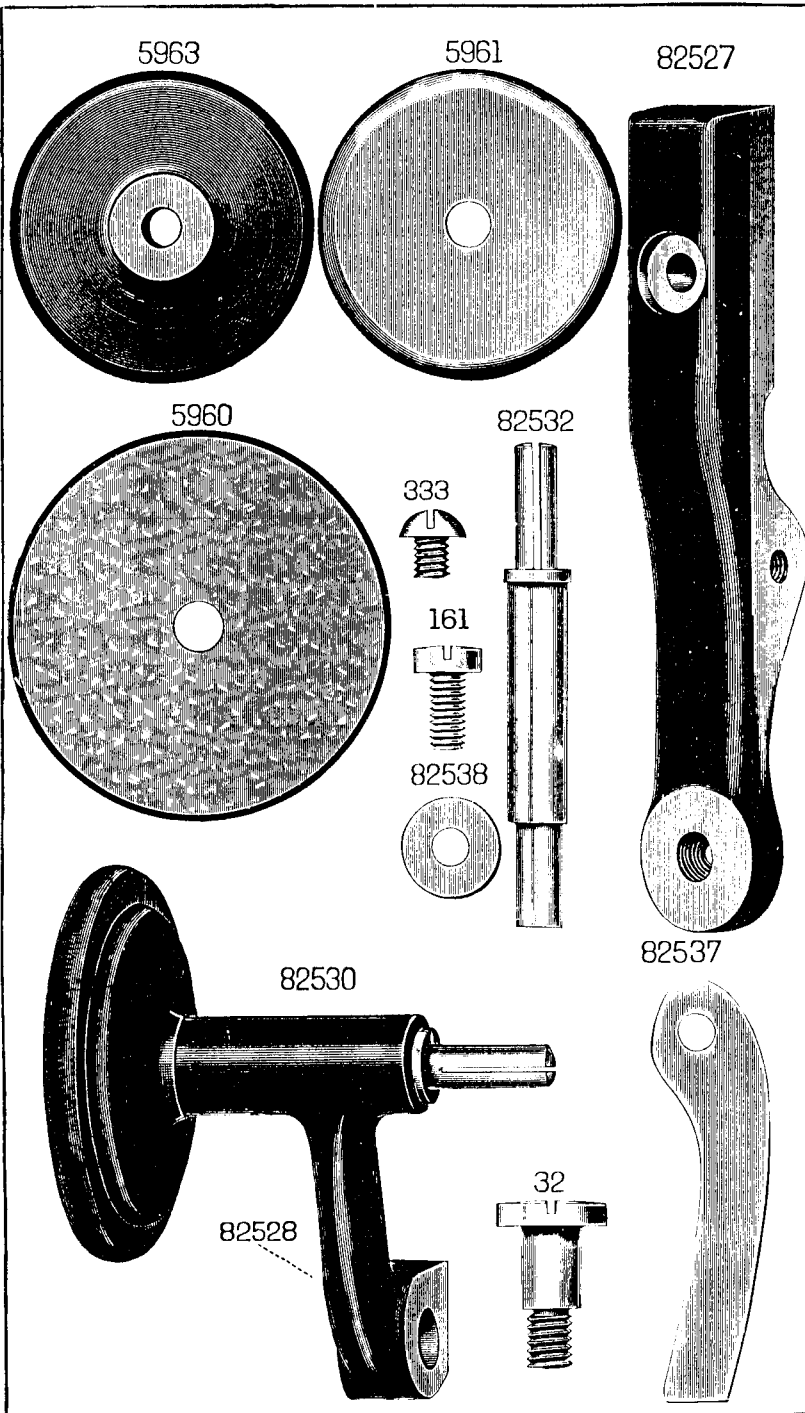

82407

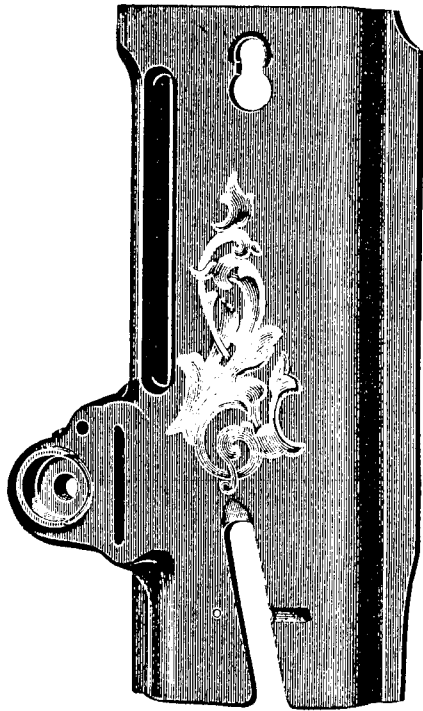

82402

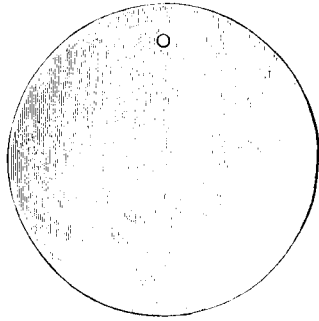

91797

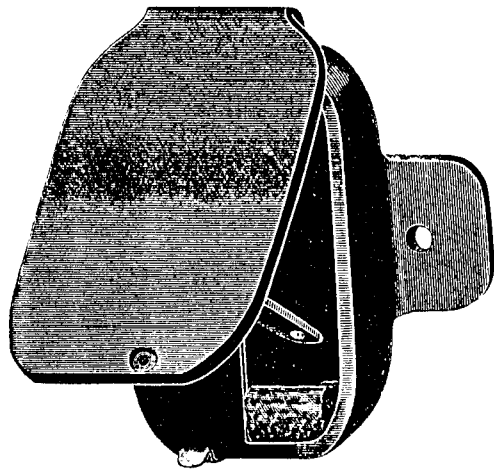

82380

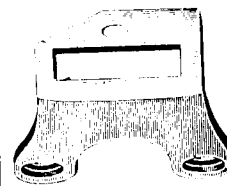

82379

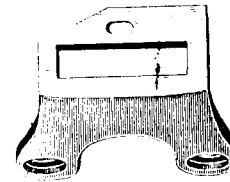

82384

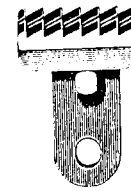

82383

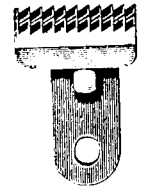

5458

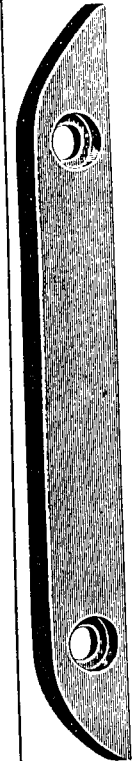

82482



82505

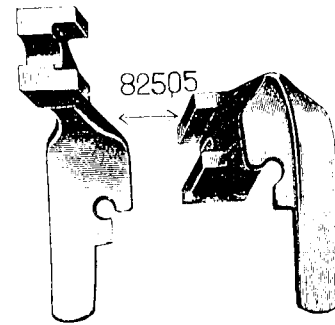

82360



82361



82551

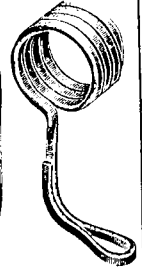

2102

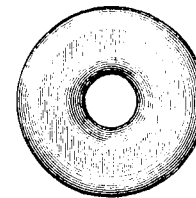

82387

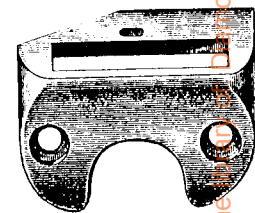

80081



82447

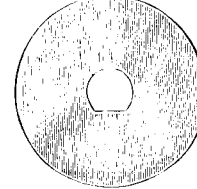

82448

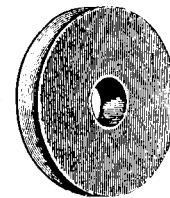

2020

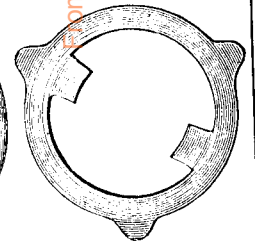

80259



82445

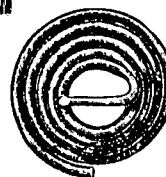

80548



2103

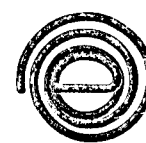

82446

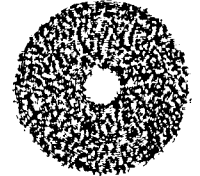

82419

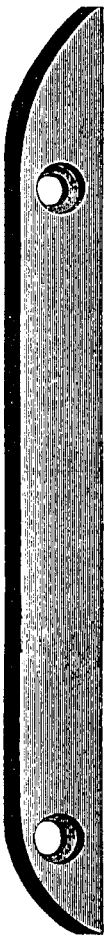

91150

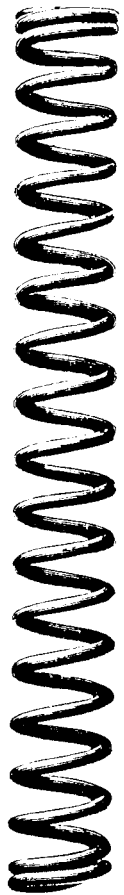

82512



82453



82513

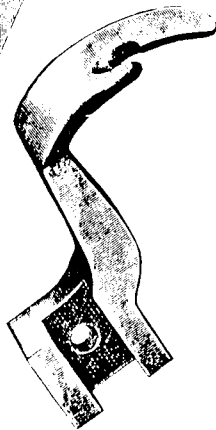

82515

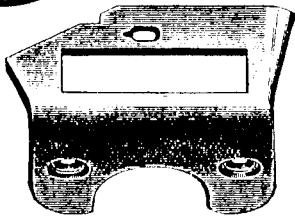

82516

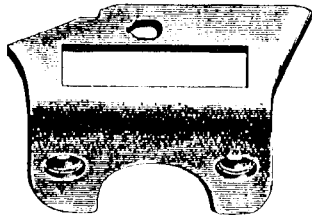

82510



82507

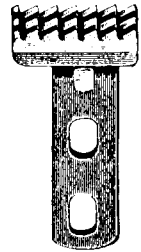

82435

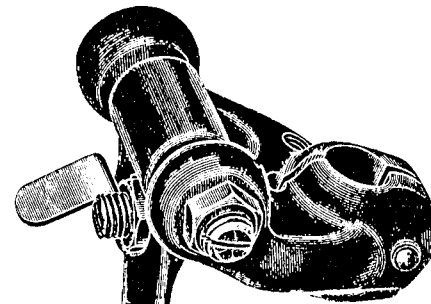

82433

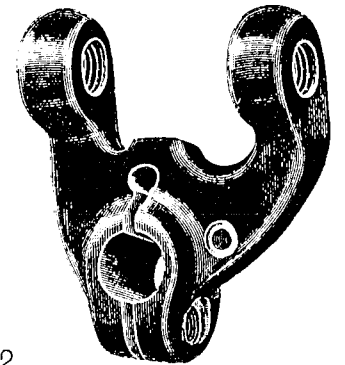

82434



82432

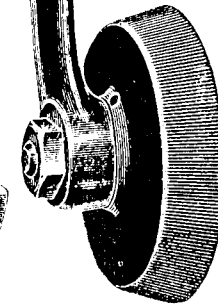

RR25



378



1520



SS329



313



430



From the library

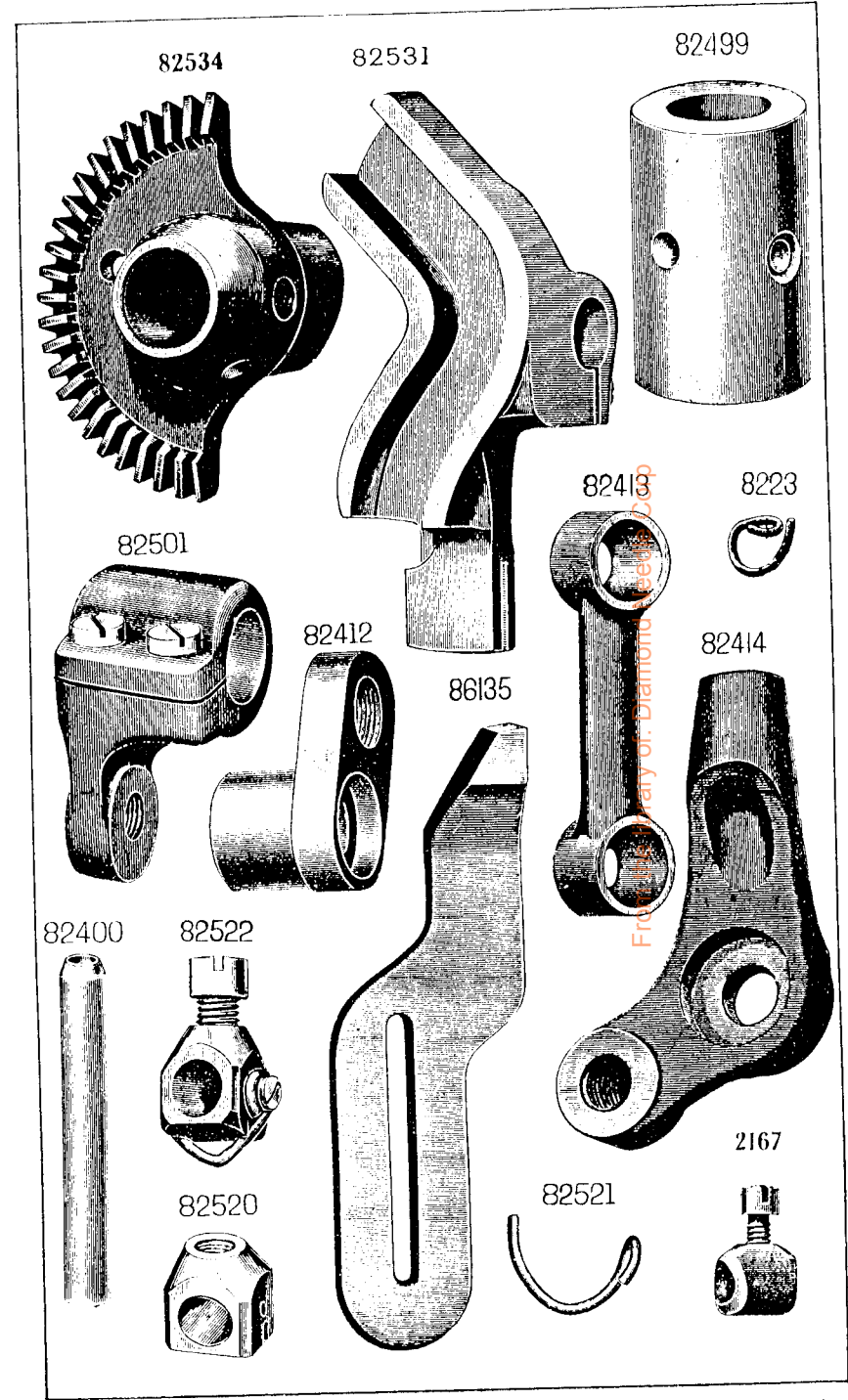
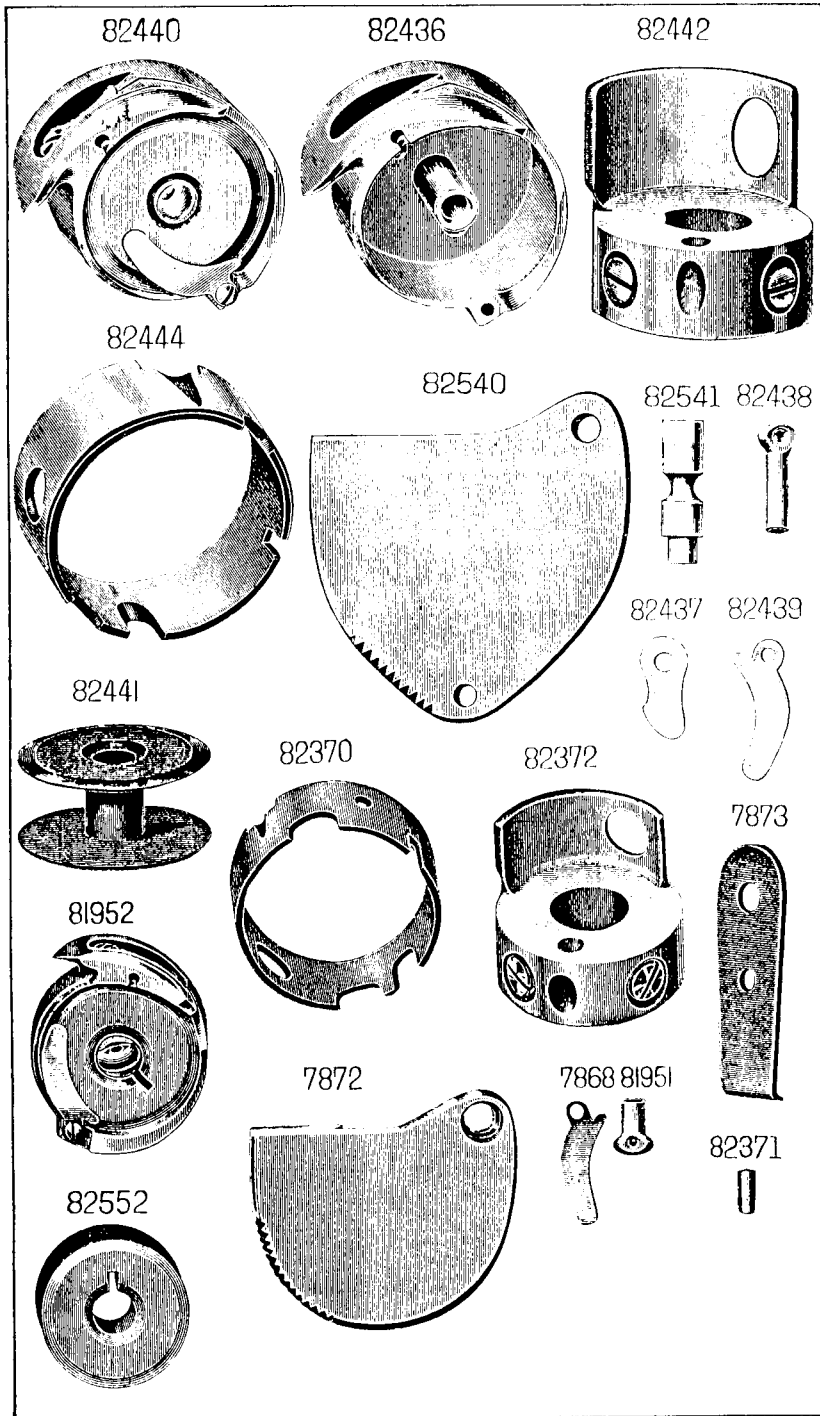

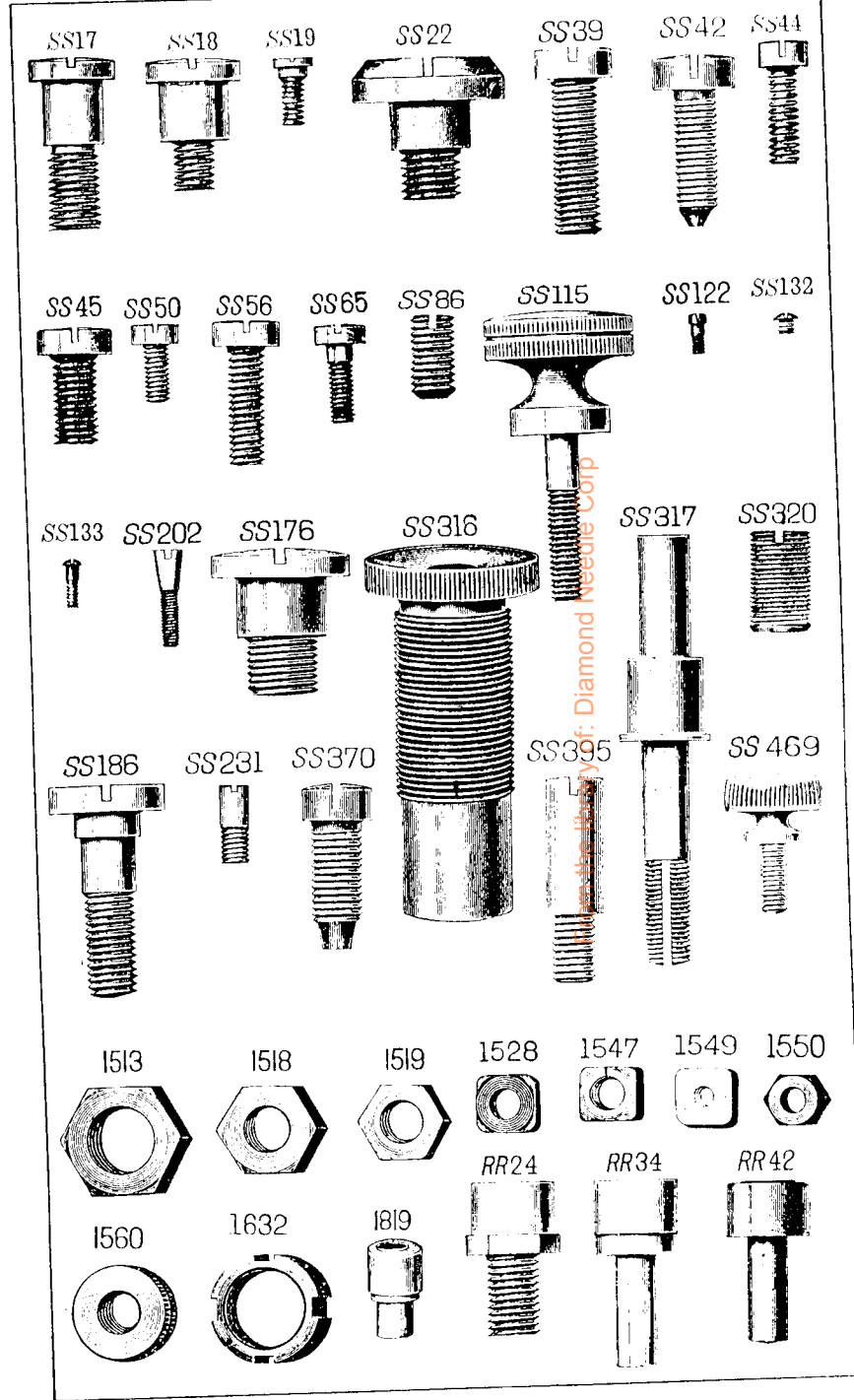
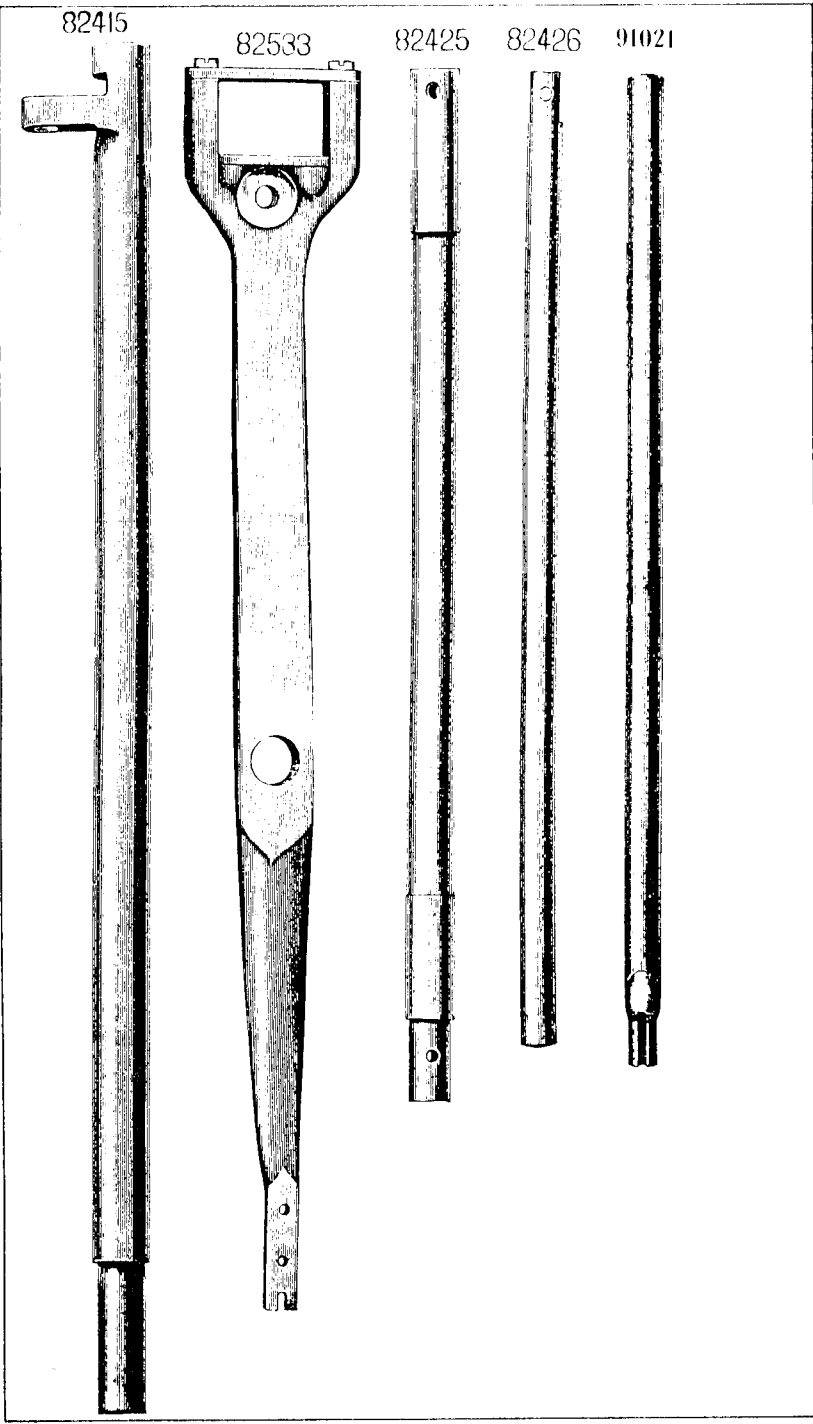

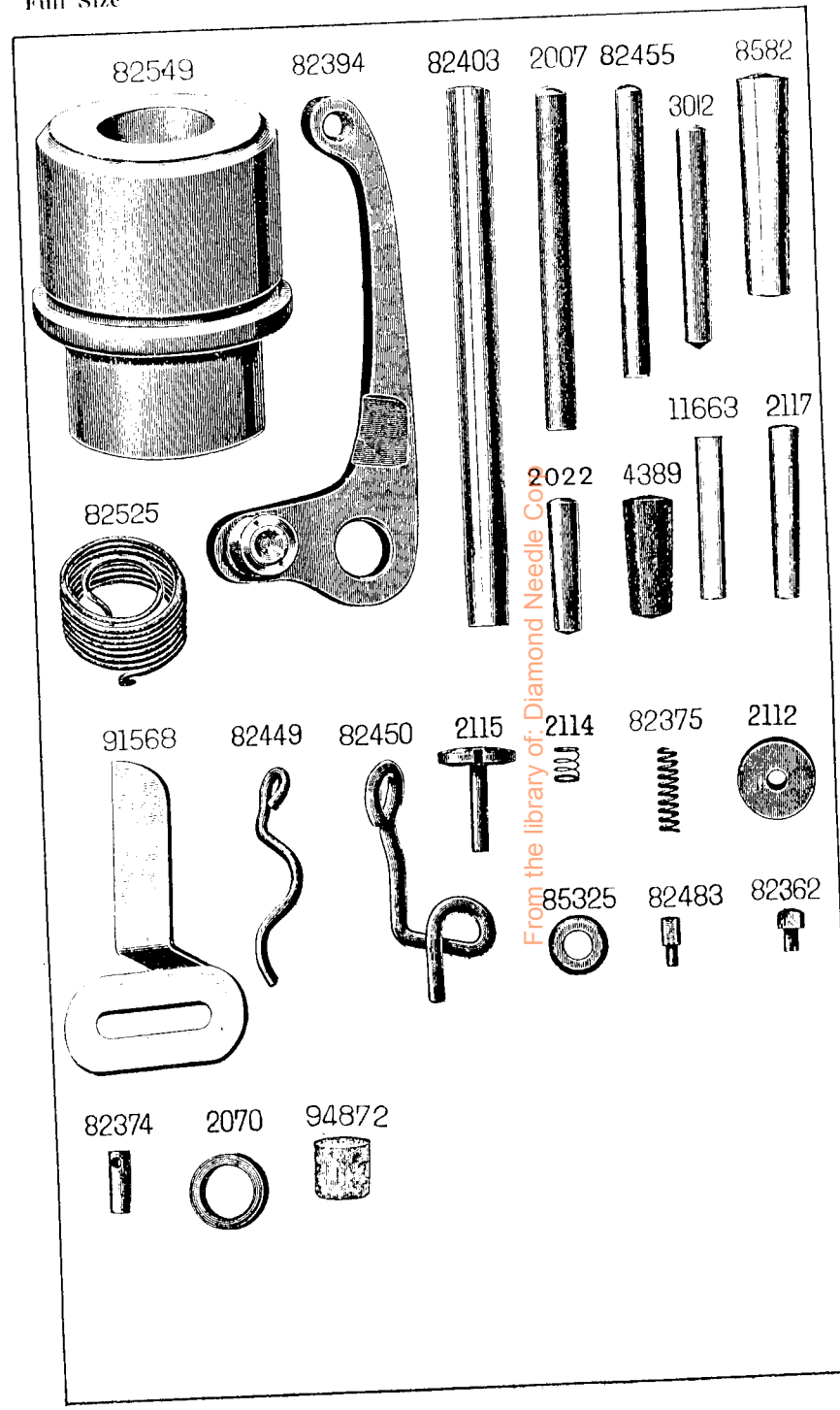
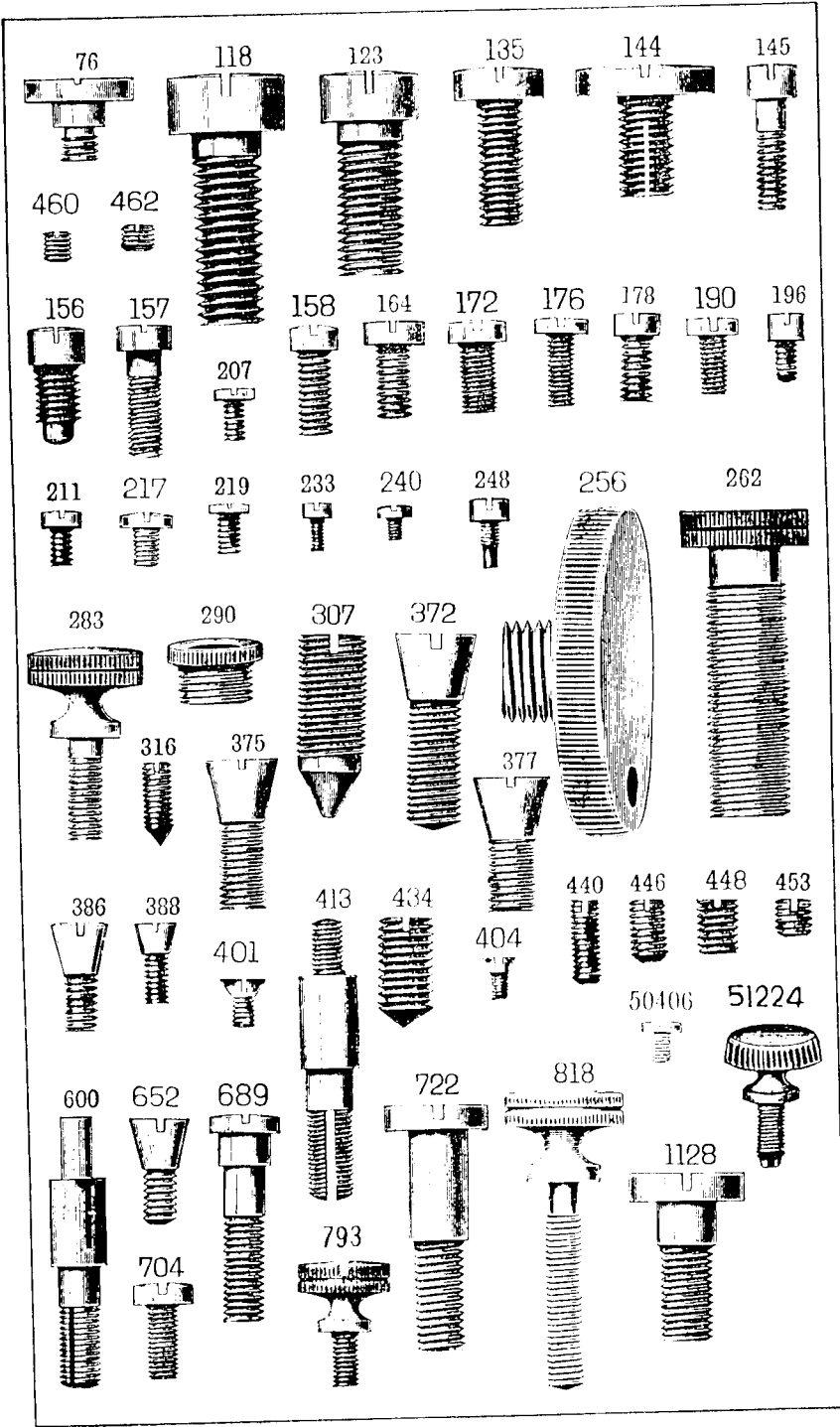

From the library of: Diamond Needle Co.

INSTRUCTIONS FOR ORDERING

In ordering from this List, the prefix and affix letters with the part number **MUST BE** quoted exactly as they are shown in the first column.

A number always indicates the same part in whatever List it may appear, or for whatever machine.

The affix letters (where shown) indicate the style of finish, as follows:—

- A. Hardened, Polished, Nickel Plated and Buffed.
- A.A. Buffed and Chromium Plated.
- A.B. Hardened, Polished, Buffed and Chromium Plated.
- A.C. Brown Baking Enamel Finish.
- A.D. Grey Baking Enamel Finish.
- A.E. Hardened, Bright Rumbled and Nickel Plated.
- A.F. Hardened, Bright Rumbled and Nickel Plated, Bright Rumbled and Chromium Plated.
- A.J. Polished, Nickel Plated and Chromium Plated.
- A.K. Hardened, Polished, Nickel Plated and Chromium Plated.
- A.L. Heat Treated for Toughness.
 - B. Polished, Nickel Plated and Buffed.
 - C. Hardened only.
- C.R. Hardened and Merlized.
 - D. Polished only.
 - E. Soft, not Polished.
 - F. Hardened and Polished.
- F.J. Hardened, Polished and Nickel Plated.
- G. Bright Rumbled and Nickel Plated.
- H. Blued.
- J. Nickel Plated only.
- K. Hardened and Nickel Plated.
- L. Brass Plated.
- M. Oxidized.
- N. Japanned, Dull.
- P. Japanned, Bright.
- P.P. Wrinkle Finish.
- R. Merlized.
- S. Cadmium Plated.
- T. Copper Plated.
- T.A. Hardened, Polished, Copper and Nickel Plated and Buffed.
- T.B. Copper and Nickel Plated and Polished.
- T.J. Copper and Nickel Plated only.
- T.K. Hardened, Copper and Nickel Plated.
- T.E. Copper and Brass Plated.
- T.M. Copper Plated and Oxidized.
 - U. Zinc Plated.
 - V. Silver Plated.
 - W. Polished and Nickel Plated.
 - X. Black Oxide for Iron and Steel.
- X.C. Hardened and Black Oxide for Iron and Steel.
 - Y. Black Nickel Plated only.
 - Z. Chromium Plated.
- Z.A. Hardened, Polished, Nickel Plated, Buffed and Chromium Plated.
- Z.B. Polished, Nickel Plated, Buffed and Chromium Plated.
- Z.C. Hardened and Chromium Plated.
- Z.D. Polished and Chromium Plated.
- Z.G. Bright Rumbled, Nickel Plated, Bright Rumbled and Chromium Plated.
- Z.J. Nickel and Chromium Plated.
- Z.T. Copper and Chromium Plated.

Parts marked with an asterisk (*) are furnished only when the repairs are made at Factory.

PARTS COMPLETE

FOR

No. 34K1 MACHINE

DROP FEED. PILLAR 11" HIGH. LIFTING PRESSER.

(Obsolete)

No.	Plate				
*82351		Arm with 48c, 3005 and 449
123e	2600	" Screw (3)
4389	2601	" Steady Pin (2)
12453		" Oil Tube
82352		Arm Pillar
135e	2600	" " Screw (3)
4389	2601	" " Steady Pin
283d	2600	" " Thumb Screw (only supplied when machine is fitted with Extension Table and at an extra charge).
80795		Arm Shaft for Tight Wheel Machine
80501		" " for Loose Wheel Machine
3005	242	" " Bushing (back)
448c	2600	" " " (") Set Screw
449		" " " (front)
444c	2600	" " Screw for 80795
1288		Arm Side Cover
51224d	2600	" " " Thumb Screw
2007	2601	" Spool Pin
8582	2601	" Steady Pin
7370		Balance Wheel with two 448c (Tight Wheel)
80504		" " (Loose Wheel)
448c	2600	" " Set Screw
*82353		Bed
256w	2600	Clamp Stop Motion Clamp Screw
248d	2600	" " " " Stop Screw
2020	2593	" " " " Washer
*3023		" " " Flanged Bushing
4933		" " " " " with two 462al
2022	2601	" " " " " Pin
462al	2600	" " " " " Set Screw
3022		Clamp Stop Motion, complete, Nos. 248d, 256w, 2020 and 4933

From the library of: Diamond Needle Corp

PARTS FOR No. 34KI MACHINE

No.	Plate	
82354	241	Crank Connecting Rod with 145c, 7927, 94872 and two 158c
145c	2600	" " " Adjusting Screw
*7927	---	" " " Cap
94872	2601	" " " " Oil Pad
158c	2600	" " " " Screw
SS17c	2599	" " " Hinge Screw
1518c	2599	" " " " " Nut
82363	240	Face Plate
164d	2600	" " Screw
82369	---	Face Plate , complete, Nos. 145c, 460c, 2111, 16202, 80081, 80259, 80548, 80688, 82358, 82363, two each 233d and 2102 for Machine without Foot or Knee Lifter
82551	---	Face Plate , complete, Nos. 145c, 460c, 2111, 16202, 80259, 80548, 80688, 82358, 82363, 82553, two each 233d and 2102 for Machine with Foot or Knee Lifter
3032	242	Feed Cam with 446c
446c	2600	" " Set Screw
52165	242	Feed Connecting Link
375c	2600	" " " Hinge Screw
1518c	2599	" " " " " Nut
82360	2593	Feed Dog (fine) with 82362
82361	2593	" " (coarse) with 82362
82362	2601	" " Steady Pin
219c	2600	" " Screw
<i>NOTE:—No. 82361 is sent with this machine unless otherwise specified on order.</i>		
82355	241	Feed Forked Connection with 145c
145c	2600	" " " Adjusting Screw
SS17c	2599	" " " Hinge Screw
1518c	2599	" " " " " Nut
82356	241	Feed Lever with 82357 and two 176d
*82357	248	" " Cap
176d	2600	" " " Screw
93418	242	" " Connecting Crank
722d	2600	" " " Hinge Screw
82359	242	" " " Link
377c	2600	" " " Hinge Screw for 82356
1519c	2599	" " " " " Nut for 82356
372c	2600	" " " " " for 93418
1518c	2599	" " " " " Nut for 93418
SS18d	2599	" " Hinge Screw

PARTS FOR No. 34KI MACHINE

No.	Plate	
3039	242	Feed Regulator
1128c	2600	" " Hinge Screw
818d	2600	" " Thumb Screw
7860	241	Feed Rock Shaft
82390	---	" " " 7860 with 82501
82501	2597	" " " Crank with two 157c
157c	2600	" " " Clamping Screw
307c	2600	" " " Screw Centre
1513c	2599	" " " " " Nut
†85980	---	Guide
†51224d	---	" Thumb Screw
82391	---	Lifting Presser Plunger
82389	248	" " " 82391 with 8386 and 82392
82392	---	" " " Roller
8386	---	" " " " Pin
80559b	---	" " " Yoke
178b	2600	" " " " Set Screw
SS14b	2599	" " " " Clamping Screw
80686b	248	" " " " 80559b with SS14b and 178b
5456	240	Needle Bar (for Round Shank Needle)
82472	248	" " Cam with two 172c
172c	2600	" " " Clamping Screw
5458	2593	" " " Guide
158c	2600	" " " " Screw
290c	2600	" " " Screw Bushing
2167	2597	Needle Clamp with 196d
196d	2600	" " Screw
8223	2597	" " Thread Eyelet
233d	2600	" " " " Screw
7862	241	Oscillating Rock Shaft
82367	242	" " " Feed Raising Cam Segment Gear with 446c
446c	2600	" " " " " " " " " " " Gear Set Screw
2117	2601	" " " " " " " " " " " Gear Pin
307c	2600	" " " Screw Centre
1513c	2599	" " " " " Nut
82365	241	Oscillating Shuttle Shaft
82366	242	" " " Bevel Pinion Gear with 453c
453c	2600	" " " " " " " " " " " Set Screw
11663	2601	" " " " " " " " " " " Pin

† Only supplied when machine is fitted with Extension Table and at an extra charge.

PARTS FOR No. 31KI MACHINE

No.	Plate	
3054	241	Presser Bar
80269	248	" " Lifter
689c	2600	" " " Hinge Screw
1520r	2595	" " " " " Nut
80687	242	" " Lifting Bracket with 453c
453c	2600	" " " " " Set Screw
82498	248	" " " " " Cam
704c	2600	" " " " " Screw
290c	2600	" " " " " Screw Bushing
82517	"	" " " " " Spring
2070	2601	" " " " " Washer
262d	2600	" " " " " Regulating Thumb Screw
1632	2599	" " " " " " " Lock Nut
80569	248	" " " " " " " Wrench
82368	248	Presser Foot
82505	2593	" " (Ribbed on Sole)
176d	2600	" " " " " Screw

NOTE. No. 82368 is sent with this machine unless otherwise specified on order.

1867		Roller , $\frac{9}{16}$ " Coarse, with 388d and 1550j for 2194
1843		" $\frac{9}{16}$ " Fine, " 388d " 1550j " 2195
1868		" $\frac{7}{8}$ " Coarse, " 652d " 1528j " 2196
1841		" $\frac{7}{8}$ " Fine, " 652d " 1528j " 2197
1839		" $1\frac{1}{4}$ " Coarse, " 386d " 1528j " 16099
1869		" $1\frac{1}{4}$ " Fine, " 386d " 1528j " 16100
1870		" $1\frac{1}{2}$ " Coarse, " 386d " 1528j " 2200
1853		" $1\frac{1}{2}$ " Fine, " 386d " 1528j " 2201
2202		" " Arm for 2194 and 2195
2203		" " " " 2196 " 2197
16098		" " " " 16099 " 16100
4863		" " " " 2200 " 2201
440f	2600	" " " " " Adjusting Screw
1547h	2599	" " " " " " " Nut
2206		" " " " " " " Bracket for 2194 to 2197
4282		" " " " " " " 16099 and 16100
4367		" " " " " " " 2200 " 2201
316f	2600	" " " " " " " Screw Centre
1547h	2599	" " " " " " " " " Nut
2205		" " " " " " " Lock Spring
176f	2600	" " " " " " " " " Screw
1549d	2599	" " " " " " " " " Nut
80107		Wrench
2194	—	Roller Presser , complete, $\frac{9}{16}$ " (Coarse Roller), Nos. 176f, 440f, 1549d, 1867, 2202, 2205, 2206, two 316f and three 1547h

PARTS FOR No. 31KI MACHINE

No.	Plate	
2195		Roller Presser , complete, $\frac{9}{16}$ " (Fine Roller), Nos. 176f, 440f, 1549d, 1843, 2202, 2205, 2206, two 316f and three 1547h
2196		Roller Presser , complete, $\frac{7}{8}$ " (Coarse Roller), Nos. 176f, 440f, 1549d, 1868, 2203, 2205, 2206, two 316f and three 1547h
2197		Roller Presser , complete, $\frac{7}{8}$ " (Fine Roller), Nos. 176f, 440f, 1549d, 1841, 2203, 2205, 2206, two 316f and three 1547h
16099		Roller Presser , complete, $1\frac{1}{4}$ " (Coarse Roller), Nos. 176f, 440f, 1549d, 1839, 2205, 4282, 16098, two 316f and three 1547h
16100		Roller Presser , complete, $1\frac{1}{4}$ " (Fine Roller), Nos. 176f, 440f, 1549d, 1869, 2205, 4282, 16098, two 316f and three 1547h
2200		Roller Presser , complete, $1\frac{1}{2}$ " (Coarse Roller), Nos. 176f, 440f, 1549d, 1870, 2205, 4367, 4863, two 316f and three 1547h
2201		Roller Presser , complete, $1\frac{1}{2}$ " (Fine Roller), Nos. 176f, 440f, 1549d, 1853, 2205, 4367, 4863, two 316f and three 1547h
		NOTE. Roller Presser is only supplied when specified on order and at an extra charge.
190d	2600	Roller Presser Screw
388d	2600	" " " " " Screw for 1843 and 1867
652d		" " " " " 1841 " 1868
386d	2600	" " " " " 1839, 1853, 1869 and 1870
1550j	2599	" " " " " Nut for 388d
1528j	2599	" " " " " " " 386d and 652d
82552	2596	Shuttle Bobbin (solid, hardened)
7868	2596	" " " " " Retaining Spring
SS133d	2599	" " " " " " " Screw
81993		" " " " " " " Body
81994	—	" " " " " " " Tension Spring
SS132d	2599	" " " " " " " Screw
81951	2596	" " " " " " " Thread Pull-off
404d	2600	" " " " " " " Screw
81952	2596	Shuttle , complete, Nos. SS132d, SS133d, 404d, 7868, 81951, 81993, 81994 and 82552
82372	2596	Shuttle Carrier with two 453c
453c	2600	" " " " " Set Screw
82373	248	" " " " " Cover
SS19d	2599	" " " " " Hinge Screw
82482	2593	" " " " " Latch Spring
207d	2600	" " " " " " " Screw
85325	2601	" " " " " " " Washer
82483	2601	" " " " " " " Steady Pin
82374	2601	" " " " " " " Retaining Pin
SS122e	2599	" " " " " " " Guide Screw
82375	2601	" " " " " " " Spring
82376	242	" " " " " " " Lifter
82370	2596	" " " " " " " Ring Seat
82371	2596	" " " " " " " Fixing Pin

From the library of: Diamond Needle Corp.

PARTS FOR No. 34K1 MACHINE

No.	Plate					
2102	2593	Tension Disc
80081	2593	"	Release Pin for 82369
82553	---	"	Releasing Lever for 82554
80548	2593	"	Spring
*600c	2600	"	Screw Stud
16202	---	"	" " 600c with 1560d
145e	2600	"	" " Clamping Screw
1560d	2599	"	" " Regulating Thumb Nut
82358	248	Thread Guard
233d	2600	"	" Screw
2112	2601	Thread Retaining Disc	with 2113
2113	---	"	" " Steady Pin
2114	2601	"	" Spring
2115	2601	"	" Stud
460c	2600	"	" " Set Screw
2111	---	Thread Retainer Guide ,	complete, Nos. 2112, 2114 and 2115
82378	---	Thread Take-up Cam	(Steel) with 446c and 453c
3012	2601	"	" " Pin
RR42	2599	"	" " Roller and Stud
453c	2600	"	" " " Set Screw
446c	2600	"	" " " Set Screw
82377	248	"	" " 82378 with RR42, 82498 and two 704c
82394	2601	"	" " Lever with 1819
76d	2600	"	" " Hinge Screw
1819	2599	"	" " Roller and Stud
80259	2593	"	" " Spring...
80688	---	"	" " Regulator Plate
233d	2600	"	" " " Screw
82379	2593	Throat Plate	(fine)
82380	2593	"	" (coarse)
211f	2600	"	" Screw
NOTE.	No. 82380 is sent with this machine unless otherwise specified on order.					
87346	---	Drip Pan

PARTS SPECIAL

TO

No. 34K5 MACHINE

DROP FEED. PILLAR 7" HIGH. LIFTING PRESSER.

This Machine is the same as No. 34K1 with the following exceptions :-

No.	Plate					
82395	240	Arm Pillar
*82381	---	Bed
7883	240	Crank Connecting Rod	with 7927, 94872 and two 158c
372c	2600	"	" " Hinge Screw
82383	2593	Feed Dog	(fine) with 82362
82384	2593	"	" (coarse) with 82362
NOTE.	No. 82383 is sent with this machine unless other Feed Dog is specified on order.					
7884	240	Feed Forked Connection
372c	2600	"	" " Hinge Screw
82382	240	Feed Lever	with 82357 and two 176d
82385	240	Oscillating Shuttle Shaft
7872	2596	Shuttle Cover
7873	2596	"	" Latch Spring
82371	2596	"	" " Steady Pin
82387	2593	Throat Plate	(fine)
82388	---	"	" (coarse)
NOTE.	No. 82388 is sent with this machine unless otherwise specified on order.					

From the library of: **Diamond Needle Corp.**

PARTS COMPLETE FOR No. 34K11 MACHINE

DROP FEED. PILLAR 11" HIGH. LARGE SHUTTLE FOR HEAVY WORK.

No.	Plate	
*82396	-	Arm with 446c, 82499 and 82549
118c	2600	" Screw (3)
8582	2601	" Steady Pin (2)
82542		Arm Pillar
135e	2600	" " Screw (3)
8582	2601	" " Steady Pin (2)
283d	2600	" " Thumb Screw <i>(only supplied when machine is fitted with Extension Table and at an extra charge).</i>
82545	-	Arm Shaft
82499	2597	" " Bushing (back)
446c	2600	" " " (") Set Screw
82549	2601	" " " (front)
82400	2597	" " Oil Tube
144c	2600	" " Screw
82402	2592	Arm Side Cover
51224d	2600	" " " Thumb Screw
82403	2601	" Spool Pin
82404	2591	Balance Wheel (two speed) with two 434c
434c	2600	" " Set Screw
*82405		Bed
82406	2591	Crank Connecting Rod with SS44c, 7927, 94872 and two 158c
SS44c	2599	" " " Adjusting Screw
*7927	-	" " " Cap
94872	2601	" " " Oil Pad
158e	2600	" " " Screw
SS17c	2599	" " " Hinge Screw
1518e	2599	" " " " Nut
82407	2592	Face Plate
SS45d	2599	" " Screw
82408		Face Plate , complete, Nos. SS50f, 233d, 446c, 82407, 82449, 82450, 82455, 82502, 82503, 82525 and 82551
3032	242	Feed Cam with 446c
446c	2600	" " Set Screw

PARTS FOR No. 34K11 MACHINE

No.	Plate	
52165	242	Feed Connecting Link
375c	2600	" " " Hinge Screw
1518c	2599	" " " " Nut
82507	2591	Feed Dog (three rows of teeth) with 82362
217f	2600	" " Screw
82362	2595	" " Steady Pin
82410	2591	Feed Forked Connection with SS44c
SS44c	2599	" " " Adjusting Screw
SS17c	2599	" " " Hinge Screw
1518c	2599	" " " " Nut
82533	2598	Feed Lever with 82357, 82535, two each 176d and 401e
*82535		" " Cam Bearing Strip
401e	2600	" " " " Screw
*82357	248	" " Cap
176d	2600	" " " Screw
82412	2597	" " Connecting Crank
722d	2600	" " " " Hinge Screw
82413	2597	" " " Link
377c	2600	" " " " Hinge Screw for 82533
1519c	2599	" " " " Nut for 82533
375c	2600	" " " " Nut for 82412
1518c	2599	" " " " Nut for 82412
SS176d	2599	" " Hinge Screw
82414	2597	Feed Regulator
1128c	2600	" " Hinge Screw
SS115d	2599	" " Thumb Screw
82415	2598	Feed Rock Shaft
82416		" " " 82415 with 82501
82501	2597	" " " Crank with two 157c
157c	2600	" " " " Clamping Screw
307c	2600	" " " Screw Centre
1513c	2599	" " " " Nut
*86135	2597	Guide
*793d	2600	" Thumb Screw
91021	2598	Needle Bar
82531	2597	" " Cam with SS202c and two 704c
SS202c	2599	" " " Adjusting Screw
704c	2600	" " " Clamping Screw
82419	2591	" " " Guide
158c	2600	" " " Screw
KK31	2599	" " " Roller and Stud

* Only supplied when machine is fitted with Extension Table and Work Plate, and at an extra charge.

From the library of The Diamond Needle Corp.

PARTS FOR No. 34KH MACHINE

No.	Plate	
82520	2597	Needle Clamp ...
156f	2600	" " Set Screw ...
82521	2597	" " Thread Eyelet ...
50406d	2600	" " " " Screw ...
82522	2597	Needle Clamp 82520 with 156f, 50406d and 82521 ...
82423	2591	Oscillating Rock Shaft ...
82534	2597	" " " Feed Raising Cam Segment Gear with 446c
446c	2600	" " " " " " " " " " Set Screw
2117	2601	" " " " " " " " " " Pin
307c	2600	" " " " " " " " " " Screw Centre
1513e	2599	" " " " " " " " " " Nut
82425	2598	Oscillating Shuttle Shaft ...
82366	242	" " " Bevel Pinion Gear with 453c
453c	2600	" " " " " " " " " " Set Screw
11663	2601	" " " " " " " " " " Pin
82426	2598	Presser Bar with Square End ...
82512	2594	" " " Lifter ...
SS186d	2599	" " " " Hinge Screw ...
1518c	—	" " " " " " " " " " Nut
82547	—	" " " Lifting Bracket with two 446c
82548	—	" " " " " 82547 with 82510 and two 190f ...
91568	2601	" " " " " Automatic Thread Controller
207f	2600	" " " " " " " " " " Screw
446c	2600	" " " " " Set Screw ...
82510	2594	" " " " " Tension Release ...
190f	2600	" " " " " " " " " " Binding Screw ...
SS316	2599	" " " Screw Bushing ...
91150	2594	" " " Spring ...
†82513	2594	Presser Foot ...
SS65f	2599	" " " Screw ...
RR25	2595	Roller (1½" diam. × ⅝" face) with 378c and 1520r ...
82432	2595	" Arm ...
82433	2595	" " Bracket ...
430c	2595	" " " Adjusting Screw ...
1520r	2595	" " " " " " " " " " Nut ...
SS329c	2595	" " " " Clamping Screw ...
82434	2595	" " " Lock Spring ...
SS50c	2599	" " " " " Screw ...
313c	2595	" " " Screw Centre ...
1519c	2599	" " " " " Nut ...

†NOTE.—No. 82513 and SS65c are only supplied with this Machine when specified on order and at an extra charge.

PARTS FOR No. 34KH MACHINE

No.	Plate	
378c	2595	Roller Bearing Screw ...
1520r	2595	" " " " Nut ...
82435	2595	Roller Presser , complete, (1½" × ⅝") Nos. RR25, SS50c, SS329c, 430c, 1520r, 82432 to 82434, two each 313c and 1519c ...
82411	2596	Shuttle Bobbin ...
82439	2596	" " Retaining Spring ...
SS133d	2599	" " " " " " " " " " Screw ...
82436	2596	Shuttle Body ...
82437	2596	" Tension Spring ...
240d	2600	" " " " " " " " " " Screw ...
82438	2596	" " Thread Pull-off ...
404d	2600	" " " " " " " " " " Screw ...
82440	2596	Shuttle , complete, Nos. SS133d, 240d, 404d, 82436 to 82439 and 82441
82442	2596	Shuttle Carrier with SS86c and 446c
446c	2600	" " " " " " " " " " Set Screw ...
SS86c	2599	" " " " " " " " " " Timing Screw ...
82540	2596	Shuttle Cover ...
82541	2596	" " " Hinge Pin ...
SS231e	2599	" " " " " " " " " " Position Screw ...
82544	—	" " " " " 82540 with 82541 ...
82374	2601	" " " Retaining Pin ...
SS122e	2599	" " " " " " " " " " Guide Screw ...
82375	2601	" " " " " " " " " " Spring ...
82376	242	" Lifter ...
82444	2596	" Ring Seat ...
82371	2596	" " " " " " " " " " Fixing Pin ...
SS317e	2599	Tension Screw Stud ...
446c	2600	" " " " " " " " " " Set Screw ...
1560d	2599	" " " " " " " " " " Regulating Thumb Nut ...
82445	2593	" Spring ...
82446	2593	" Washer (Felt) ...
82447	2593	" " (Steel) ...
82448	2593	" Wheel ...
82502	—	Tension , complete, Nos. SS317e, 1560d, 82445, 82448, two each 82446 and 82447 ...
82551	2593	Thread Controlling Lever ...
82525	2601	" " " " " " " " " " Spring ...
82455	2601	" " " " " " " " " " Stop Pin ...
82450	2601	Thread Eyelet ...
SS50f	2599	" " " " " " " " " " Screw ...
82449	2601	Thread Guard ...
233d	2600	" " " " " " " " " " Screw ...

PARTS FOR No. 34K11 MACHINE

No.	Plate				
2102	2593	Thread Retainer Disc
*413e	2600	"	"	Screw Stud	...
33892	---	"	"	"	413e with 1560d
1560d	2599	"	"	"	Regulating Thumb Nut
2103	2593	"	"	Spring...	...
82503	---	Thread Retainer , complete, Nos. 2103, 33892 and two 2102
82546	---	Thread Take-up Cam with SS320c and SS370c
SS320c	2599	"	"	"	Set Screw
453c	2600	"	"	"	for RR34
SS370c	2599	"	"	"	Timing Screw
82452	---	Thread Take-up Lever
SS22f	2599	"	"	"	Hinge Screw
RR24	2599	"	"	"	Roller and Stud
1519e	2599	"	"	"	"
82453	2594	"	"	"	82452 with RR24 and 1519e
82515	2594	Throat Plate (fine needle hole)
82516	2594	"	"	"	(coarse needle hole)
211f	2600	"	"	"	Screw
<i>NOTE. No. 82516 is sent with this machine unless otherwise specified on order.</i>					
91796	---	Oil Box
82459	---	"	"	Cover	...
82460	---	"	"	"	Hinge Pin
80106	---	"	"	"	Latch Spring
219f	2600	"	"	"	"
82462	---	"	"	"	"
82463	---	"	"	"	Washer
82463	---	"	"	"	Oil Pad (Cloth)
SS50f	2599	"	"	"	"
82462	---	"	"	"	"
SS395f	2599	"	"	"	Stud Screw
SS42f	2599	"	"	"	Set Screw
91797	2592	Oil Box , complete, Nos. SS50f, 219f, 80106, 82459, 82460, 82463, 91796 and two 82462
SS39d	2599	Oil Box Screw (to attach to machine)
82550	---	Drip Pan

Accessories

(FOR GREAT BRITAIN)

ACCESSORIES supplied with Nos. 34K1 and 34K5 Machines

No.	Plate				
82552	2596	Bobbins (2)
		Instruction Book
84112	---	Machine Button with 84151 and wood screw, 1" No. 9, R.H.B.
84151	---	Machine Button Washer (Leather)
12405	---	Machine Rest (Felt) (4)
28084	---	"	"	Nails (4)	...
36569	---	Oiler
25537	---	Screw Driver (machine)
120378	---	"	"	(shuttle tension)	...
80107	---	Wrench for 1528, 1547 and 1550
80569	248	"	"	for 1632	...

From the library of: Diamond Needle Corp

ACCESSORIES supplied with No. 34K11 Machine

No.	Plate				
82441	2596	Bobbins (2)
		Instruction Book
84118	---	Machine Button with 84151 and wood screw, 1 1/4" No. 9 R.H.B.
84151	---	Machine Button Washer (Leather)
36569	---	Oiler
11831	---	Screw Driver (machine)
120378	---	"	"	(shuttle tension)	...

Bobbin Winders

BOBBIN WINDER (Eccentric) for Nos. 34K1 and 34K5 Machines

No.	Plate	
80817	—	Eccentric
SS469d	2599	" Thumb Screw
80791	—	Frame
SS56d	2599	" Screw
2460	—	Friction Ring (Rubber)
80981	—	Pulley
82466	—	Spindle
82467	—	" 82466 with 80873 and 80981
80873	—	" Collar
82469	—	Bobbin Winder, complete, Nos. SS469d, 2460, 80791, 80817 and 82467

BOBBIN WINDER (Friction) for No. 34K11 Machine

No.	Plate	
82527	746	Bracket
SS56d	2599	" Screw
82528	746	Frame
32d	746	" Hinge Screw
5960	746	Friction Wheel (Leather)
5961	746	" " Washer
333r	746	" " " Screw
82532	746	Spindle with 15072
15072	—	" Bobbin Position Pin
5963	746	" Flange
82530	746	Frame, complete, Nos. 333r, 5960, 5961, 5963, 82528 and 82532
82537	746	Spring
161d	746	" Screw
82538	746	" " Washer
82526	—	Bobbin Winder, complete, Nos. 32d, 161d, 82527, 82530, 82537 and 82538

Knee Lifter FOR No. 34K1 Machine

No.	Plate	
82496	251	Arm Lever
82474	—	" " Connecting Chain
694d	251	" " Hinge Screw
6349	251	" " Spring
2767	251	Knee Plate with 356c
356c	251	" " Set Screw
6335	251	" " Arm
2766	251	" " " Bracket with 356c
356c	251	" " " " Set Screw
82477	251	Presser Bar Bracket with 453c
453c	2600	" " " Set Screw
2763	251	Rock Shaft
82478	—	" " 2763 with 2766, 2767, 2770, 6335, 6336 and 82480
82479	251	" " Bracket
—	—	" " " Wood Screw, 1" No. 10
6337	251	" " Lifting Bracket with two 356c
356c	251	" " " " Set Screw
82480	251	" " " " Hook
2770	251	" " Stop Dog with 356c
356c	251	" " " " Set Screw
82475	—	Knee Lifter, complete, Nos. 694d, 6349, 82474, 82477, 82478, 82496, two 82479 and four wood screws, 1" No. 10

For the library of: Diamond Needle Corp.

Knee Lifter FOR No. 34K5 Machine

This Knee Lifter is the same as 82475 with the following exceptions:—

No.	Plate	
82497	—	Arm Lever Connecting Chain
82481	—	Knee Lifter, complete, Nos. 694d, 6349, 82477, 82478, 82496, 82497, two 82479 and four wood screws, 1" No. 10